

# INSTALLATION INSTRUCTIONS

**Panasonic**

FV-GKF32S1

## GENERAL INFORMATION

Observe the following

1. This unit must be installed on a firm surface. There is a possibility of personal injury due to falling.
2. Attach parts firmly. There is a possibility of personal injury due to falling.
3. Do not install this unit in places exposed to an open flame. Plastic parts may deform and ignite to cause a fire.
4. Do not install this unit on a ceiling.  
Shutter will not function.
5. Do not install this unit where temperature may exceed 104°F (40°C) or much oily smoke is produced.  
It may cause deformation and damage to the outside hood and main body.
6. Do not use in places where chemicals and special gas are used.  
It may cause deformation and damage to the outside hood.
7. Caulk around the periphery of the unit with a caulking material so that rain water does not come in.

## PART NAMES AND DIMENSIONS

### ① Main body

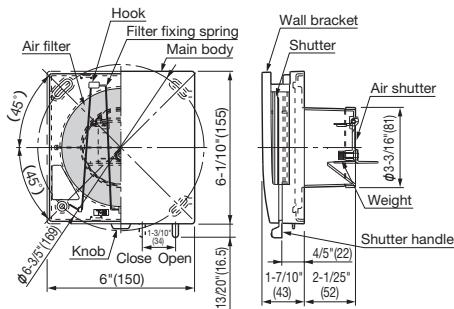

### ② Outside hood

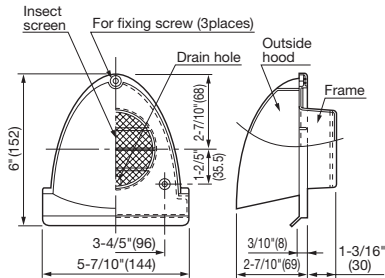

Unit: Inch (mm)

### ③ Duct × 2 pcs.

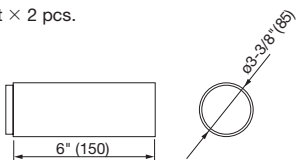

### ④ Accessories

Screw ..... 7 pcs.   
(SUS  $\phi$ 4 mm x 30 mmL)  
Operating Instructions ..... 1 (must be handed to the customer.)

## INSTALLATION METHOD (Follow the instructions below for installation.)

\*Install this unit when outer and inner walls are completed.

### ■ Main unit (Wall thickness: 4-7/20" (110 mm) - 12" (305 mm))

- ① Choose a place to install.
- ② Make a through hole ( $\phi$ 3-11/32" (85 mm)) on a wall at a downward inclination of 1/100 to 1/50 to outside.
  - If the duct is covered by an adiabatic material, make a hole including the thickness of the adiabatic material.

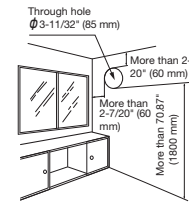

- ⑦ The knob should be pushed in all the way toward the BOTTOM mark on the main body in order to mount the wall bracket.
- ⑧ Move the shutter handle to open the shutter.

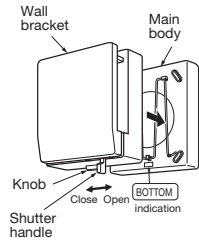

- ③ Cut out the packed duct according to the wall thickness. If the wall thickness is more than 6" (150 mm), connect two ducts with a tape to extend the length.

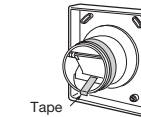

- ④ Remove the tape that fastens the air shutter.

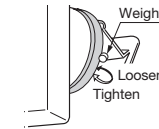

- ⑤ Adjust the weight according to the required amount of air to be ventilated in the room. (The weight should balance with the amount of air ventilated.)  
Factory setting: 18 cfm (30 cmh)  
Remove the weight: 12 cfm (20 cmh)  
(In addition to the weight, remove a hexagon nut and spring washer also.)

- When removing the weight, use a pinch or hexagon bar spanner (nominal diameter 4 mm).

- ⑥ Embed a duct in a wall, and insert the main body without the wall bracket into the duct, and secure with four screws.

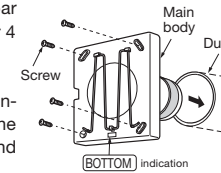

- Duct should be installed so that it has a downward inclination of 1/100 - 1/50 toward outdoor.
- Duct and wall should be sealed completely so that no rainwater comes in.
- Make sure that the duct is piped all the way to the outdoor.

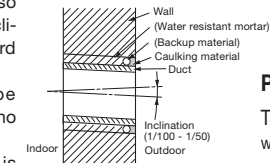

### ■ Outside hood

- ① Separate the outside hood from the frame. Insert the duct into the opening of the frame, and screw down lower part of the frame on the outer wall with two screws.

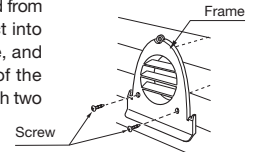

- ② Connect two hooks at the bottom of the outside hood with the frame, and push until the click sound is heard.

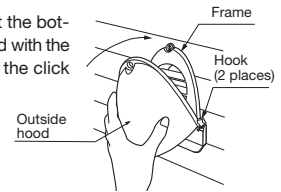

- ③ Tighten upper part of the outside hood with a screw.

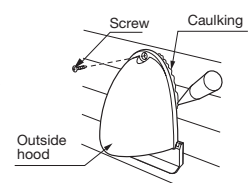

- ④ Caulk around the periphery of the unit with a caulking material so that rain water does not come in.

**Panasonic Corporation of North America**

Two Riverfront Plaza, Newark, NJ 07102  
www.panasonic.com

**Panasonic Canada Inc.**  
5770 Ambler Drive Mississauga,  
Ontario, L4W 2T3